

# LEVOLOR®

## Real Wood & Faux Wood Blinds

Persianas de madera natural y  
madera de imitación

Stores en bois véritable et simili bois

INSTALLATION • OPERATION • CARE

INSTALACIÓN • MANEJO • CUIDADO

INSTALLATION • UTILISATION • ENTRETIEN



Corded & Cordless Operation

Funcionamiento con y sin cuerda

Utilisation avec et sans cordon



# WARNING



### Window Blind Cord Can **STRANGLE** Your Child

- Children can strangle in the loop above the cord bead.
- Children can climb furniture to reach cords.
- Move crib and furniture away.
- Shorten cords to prevent reach.
- Keep cords separate – Twisted or knotted cords can create a loop.
- Keep all cords out of children's reach.

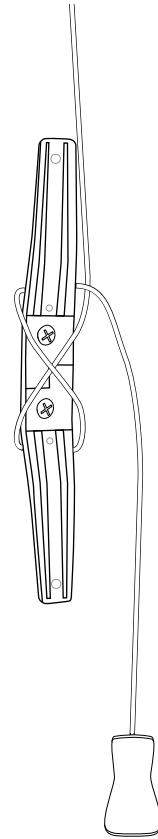

**Always wrap the cords around the cleats in a figure eight, up high, out of reach of children.**

**See additional child and cord safety messaging on page 20.**



**WARNING:** Keep all small parts, components and packaging away from children as they pose a potential choking hazard which may result in serious injury or death. Please reference all warning tags and labels in the instructions and on the blind.

**Canadian Residents Only:** For more safety information: 1-866-662-0666 or visit [www.canada.ca](http://www.canada.ca), search "blind cords".

**Window and Blind Terminology**

Mounting Types and Window Terminology .....	4
Lift Styles .....	5

**Getting Started**

Installation Overview .....	6
Components Included .....	7
Tools and Fasteners You May Need .....	8

**Installation**

Inside Mount .....	9–11
Outside Mount .....	12–14

**Installing Additional Components**

Installing Cord Cleat .....	15
Extension Brackets .....	16
Spacer Blocks .....	16
Hold-Down Brackets .....	16
Tilt Wand .....	16
Attaching Valance .....	17

**Operation**

Operating Corded .....	17
Operating Cordless .....	17

**Uninstalling**

Removing the Blind .....	18
--------------------------	----

**Cleaning and Care**.....19**Child Safety**.....20**Additional Information and Support**

Warranty .....	21
Customer Service Support .....	21
Additional Parts & Service .....	21

---

# WINDOW AND BLIND TERMINOLOGY

---

Thank you for purchasing LEVOLOR® Wood Blinds. With proper installation, operation, and care, your new blinds will provide years of beauty and performance. Please thoroughly review this instruction booklet before beginning installation.

## MOUNTING TYPES AND WINDOW TERMINOLOGY

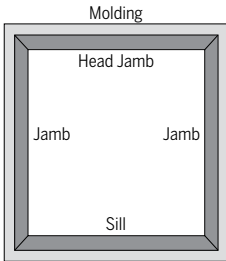

### Window Components Terminology

- Collectively, the sill and jambs are called the "window casement" or "frame".

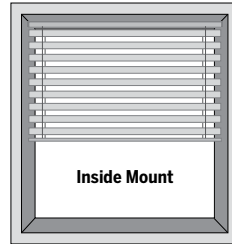

### Inside Mount

- Blind fits within window opening.
- Great for windows with beautiful trim.

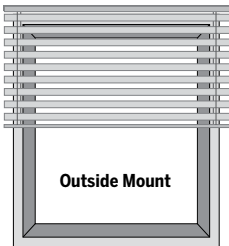

### Outside Mount

- Blind mounts outside window opening.
- Increased light control and privacy.

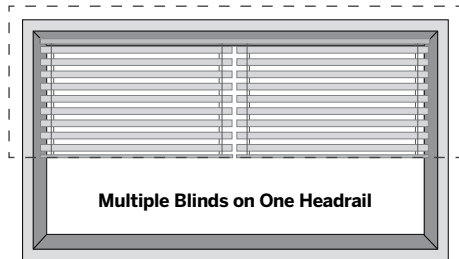

### Multiple Blinds on One Headrail

- Provides the clean appearance of a single blind with the ability to operate each blind independently.
- Can be mounted inside or outside.

### Side Mount—Not Illustrated

- Used primarily when conventional mounting will not work—for example, in an arched window opening.

LIFT STYLES

Corded Lift

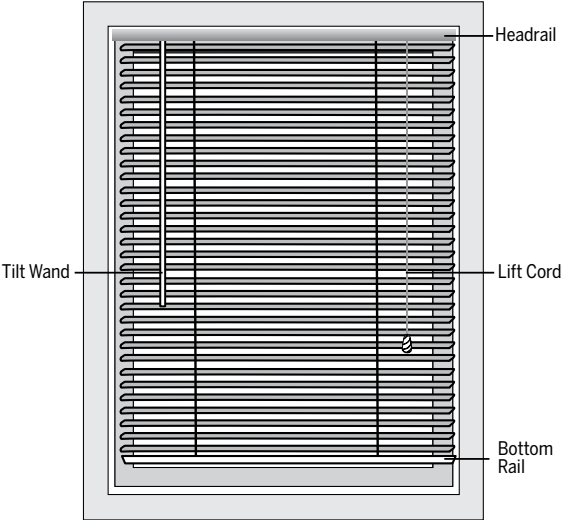

Cordless Lift

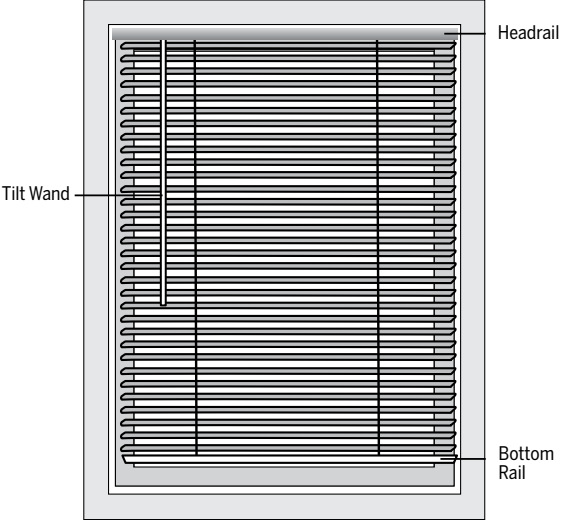

# GETTING STARTED

---

## INSTALLATION OVERVIEW

- Confirm the blind for proper width and length.
- If installing several sets of blinds, be sure to match them with the appropriate window.
- Check the installation surface to ensure you have suitable fasteners and tools.
- Lay out and organize all parts and components.
- Your order will include the correct number of installation brackets for your blind width, as shown in the table below.
- Blind orders may also include spacer blocks or extension brackets, if they were specified for added clearance.
  - Extension brackets are used for end mount blinds, as well.

<b>Installation Brackets</b>		
Your order will include the correct number of installation brackets for your blind width, as shown in the table below.		
<b>Blind Width (inches)</b>	<b>Number of Brackets per Blind</b>	
	<b>End Brackets</b>	<b>Support Brackets</b>
Up to 48	2	0
48 to 84	2	1
84 to 96	2	2
96 to 144	2	3

**COMPONENTS INCLUDED**

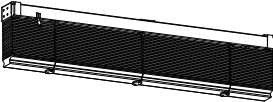

Blind

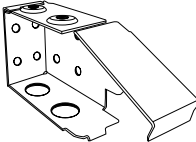

Mounting Bracket



Cord Cleat



Hex Head Screws  
(2 per Bracket)

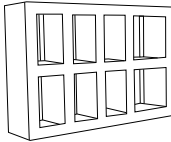

Spacer Block  
(optional)

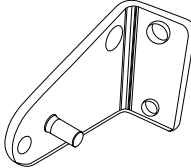

Hold Down Bracket  
(optional)

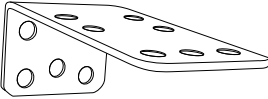

4" Extension Bracket  
(optional)

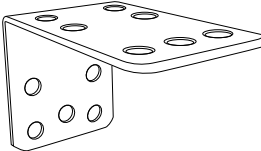

2" Extension Bracket  
(optional)

Optional items will be included, if selected at time of blind order.

## GETTING STARTED

---

### TOOLS AND FASTENERS YOU MAY NEED (not included)

The tools you will need for installing your blinds will vary, depending on the installation surface and mounting bracket type.

Tools typically used for installation include:

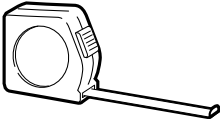

Metal Tape Measure

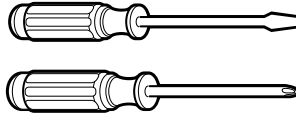

Screwdrivers  
(both flat and Phillips head)



1/4" Nutdriver



Safety Glasses

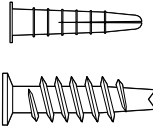

Drywall Anchors



Pencil

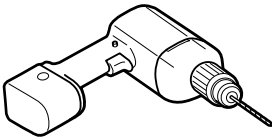

Drill with Bits



Level

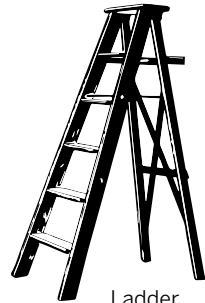

Ladder

**Note:** Longer Screws may be needed with extension brackets and spacers, not shown.



**CAUTION:** Use drywall anchors when mounting into drywall. (Not provided.) Failure to properly anchor screws could cause blind to fall possibly resulting in injury.

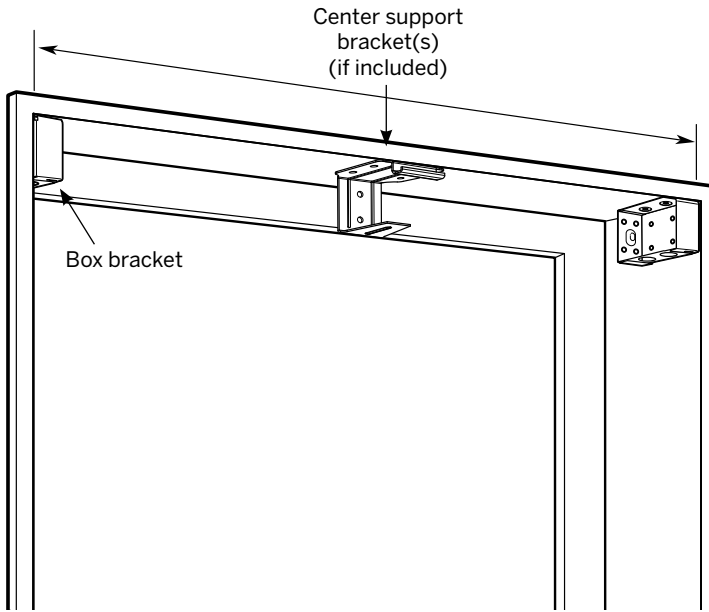

**INSIDE MOUNT (IM)****STEP 1: MARKING THE BRACKET LOCATIONS**

- Position the box brackets at the end of each headrail to confirm the dimension. Depending on installation location, box brackets can be attached using the top, back, or the side holes.
- Position the center support bracket (if included) in the center, if using only one. If more than one center support bracket is included, space them evenly along the headrail.
- Mark the location of the desired bracket mounting holes, two per bracket, making sure they are square and equally spaced.

# INSTALLATION

## INSIDE MOUNT (IM)

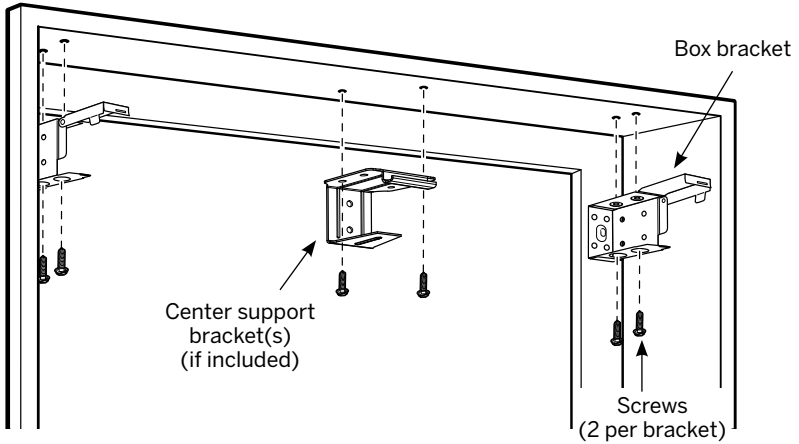

OR

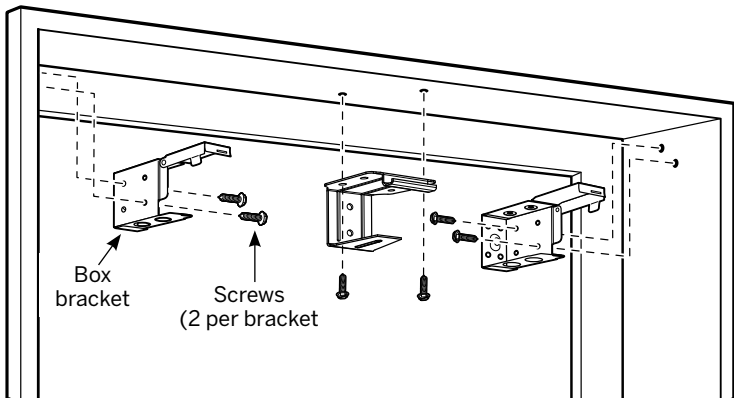

## STEP 2: INSTALLING THE BRACKETS

- Drill pilot holes using a  $\frac{1}{16}$ " drill bit using pencil marks as a guide. Depending on the installation location, box brackets can be attached using the top, back, or side holes.
- While holding the brackets in place, secure the brackets using two screws per bracket.
- Ensure all brackets are square with each other.

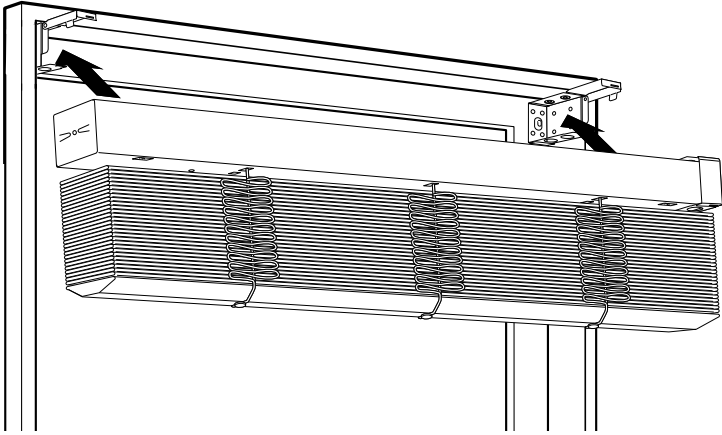
**INSIDE MOUNT (IM)****STEP 3: INSTALLING THE BLIND**

- Align the headrail with the brackets, tilt mechanism facing out.
- Slide the headrail straight back into the brackets.
- If the headrail can slide from side to side in the box brackets, use a flat-head screwdriver to bend out the tabs on the ends of the headrail until it is snug.
- If center support bracket(s) are included, hook the front edge of the headrail into the channel on the bracket.
- Lower the front of each box bracket and press until the locking tab clicks into place.



**CAUTION:** Be sure the bracket and headrail are properly secured before operating the blind. Failure to do so may result in the blind falling and possible injury.

# INSTALLATION

---

## OUTSIDE MOUNT (OM)

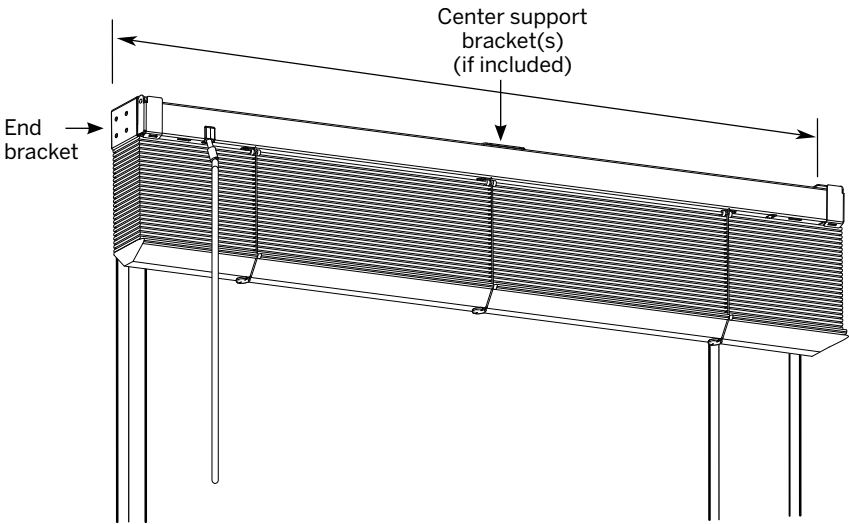

### STEP 1: MARKING THE BRACKET LOCATIONS

**IMPORTANT:** The rear of the brackets must be flush against a flat mounting surface. Do NOT mount brackets on curved molding.

- Position the box brackets at each end of the headrail
- Position the center support bracket (if included) in the center if using only one. If more than one center support bracket is included, space them evenly along the headrail.
- Use a level to ensure all brackets are even and aligned. Mark the bracket mounting hole locations, two per bracket, making sure they are square and equally spaced.

## OUTSIDE MOUNT (OM)

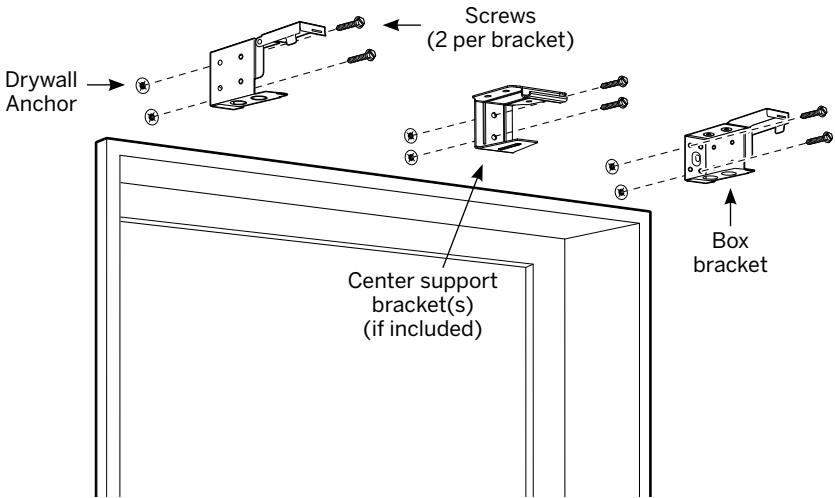

## STEP 2: INSTALLING THE BRACKETS

**IMPORTANT:** Use drywall anchors when mounting into drywall (not provided).

**IMPORTANT:** The rear of the brackets must be flush against a flat mounting surface. Do NOT mount brackets on curved molding.

- Drill pilot holes using a  $\frac{1}{8}$ " drill bit using pencil marks as a guide.
- While holding the brackets in place, secure the brackets using two screws per bracket.
- Use a level to ensure all brackets are even and square with each other.



**CAUTION:** Do not use more than one spacer block. Using more than one spacer block could cause blind to fall resulting in possible injury.

## INSTALLATION

---

### OUTSIDE MOUNT (OM)

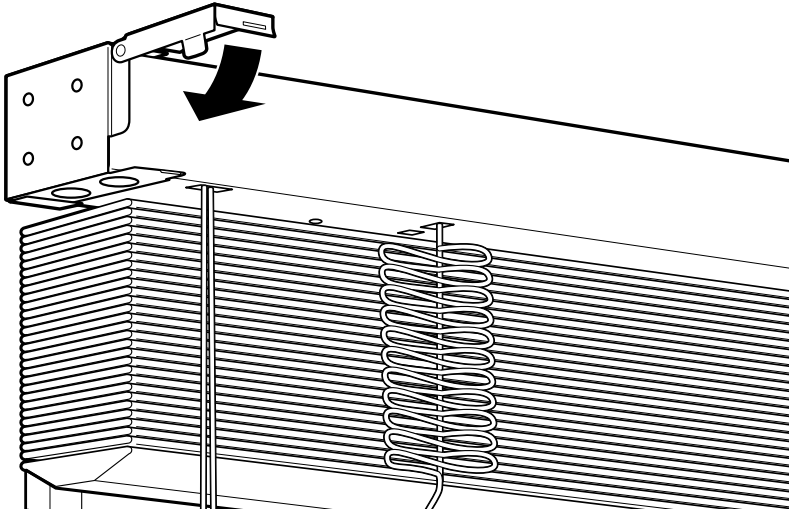

### STEP 3: INSTALLING THE BLIND

- Align the headrail with the brackets, tilt mechanism facing out.
- Slide the headrail straight back into the brackets.
- If the headrail can slide from side to side in the box brackets, use a flat-head screwdriver to bend out the tabs on the ends of the headrail until it is snug.
- If center support bracket(s) are included, hook the front edge of the headrail into the channel on the bracket.
- Lower the front of each box bracket and press until the locking tab clicks into place.



**CAUTION:** Be sure the bracket and headrail are properly secured before operating the blind. Failure to do so may result in the blind falling and possible injury.

## INSTALLING ADDITIONAL COMPONENTS

### CORDED CORD CLEAT

Refer to Cord Cleat Installation Instructions included with cord cleat for the proper way to install cord cleat.

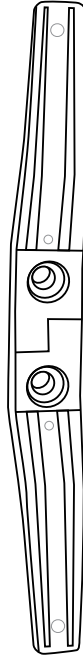

Corded Cord Cleat



**WARNING:** Always wrap the cords around the cleats in a figure eight, up high, out of reach of children. Young children can STRANGLE in cords. They can also wrap around their neck and STRANGLE.

## INSTALLING ADDITIONAL COMPONENTS

### EXTENSION BRACKETS (optional)

- Optional extension brackets offers clearance for obstructions.
- Outside mounting extension brackets will provide 2–4" clearance between the headrail and mounting surface. Assemble extension bracket as shown.
- Secure an extension bracket to each standard mounting bracket.

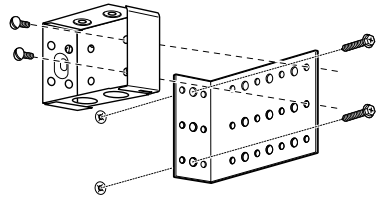

### SPACER BLOCKS (optional)

- Outside mounting spacer blocks will provide an additional  $\frac{3}{8}$ " clearance as shown.
- If spacers are used, longer screws may be required to ensure a secure installation (not provided).

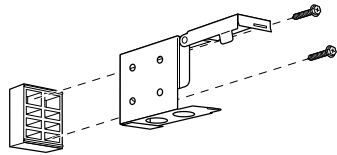

**CAUTION:** Do not use more than one spacer block. Using more than one spacer block could cause blind to fall resulting in possible injury.

### HOLD-DOWN BRACKETS (optional)

- Ideal for doors, hold-down brackets prevent blind from swaying. Assemble as shown to each side of bottom rail.

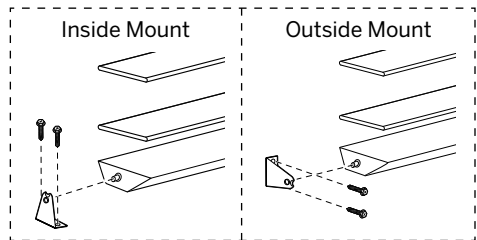
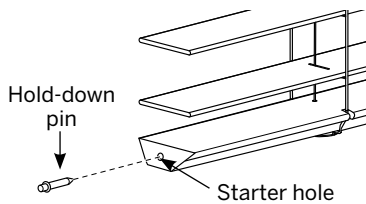

### TILT WAND (on some styles)

- Pull up the sleeve on the tilt mechanism
- Clip the end of the wand onto the tilt mechanism and pull down the sleeve on the tilt mechanism
- Rotate the tilt wand in each direction to ensure proper operation.

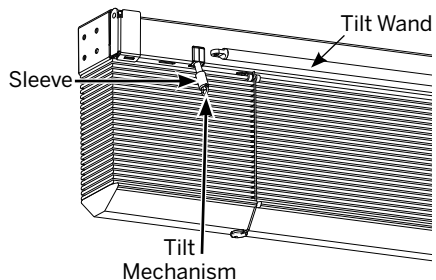



## ATTACH VALANCE

- Locate the valance clip location indicators on the backside of the valance that read "Clip Here."
- Insert the clips into the groove on the backside of the valance. Rotate so that the end marked "TOP" arrow is pointing up.
- For returns, insert L-shaped return clip into the groove on the backside of the valance return. Align and insert the other end of the L-shaped return clip into the groove on the backside of the valance.
- Align the clips with the slots on the bottom of the headrail and clip into place.

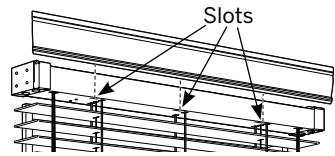
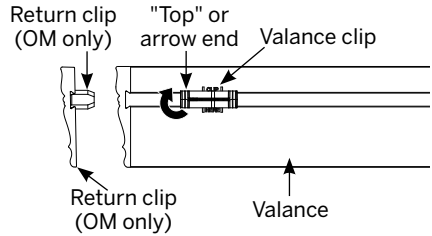

## CORDED

**NOTE:** Tilt and Lift cords may be located on the left or right side of the product depending on what was selected when ordering.

**NOTE:** Wand tilt is the standard / default tilt feature, tilt cords are available as an option.

- To raise the blind pull cord in toward the center of the blind to release the lock; this allows you to raise and lower the blind. Once the blind is at the desired height, pull the cord away from the center to lock into position.
- To tilt the slats open or closed, pull the tilt cords up and down to reach desired position.

Corded

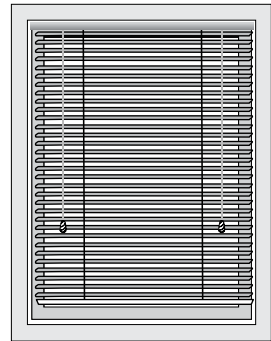

Cordless

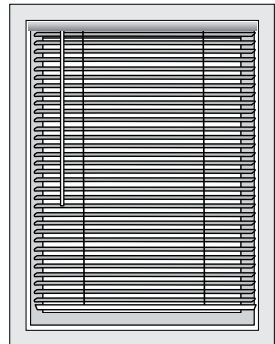

## CORDLESS

- To raise the blind, firmly press and hold the LEVOLOR button located on the bottom rail and lift the blind to the desired position. Once desired position is reached, release grip on the button to lock blind in place.
- To tilt slats open and closed, rotate the tilt wand to achieve desired position.

# UNINSTALL

## REMOVING THE BLIND

First make sure that the blind is fully raised. Unlock and lift the front clips of each end box bracket and slide the headrail out of the brackets. If center support brackets are used, lift the front of the headrail up to clear the channel of the bracket and slide out forward.

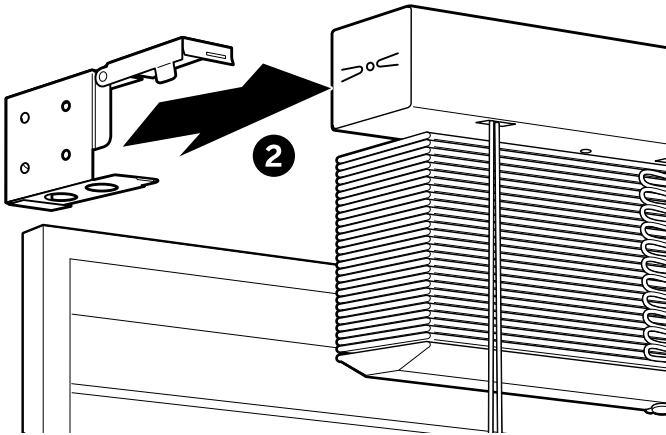
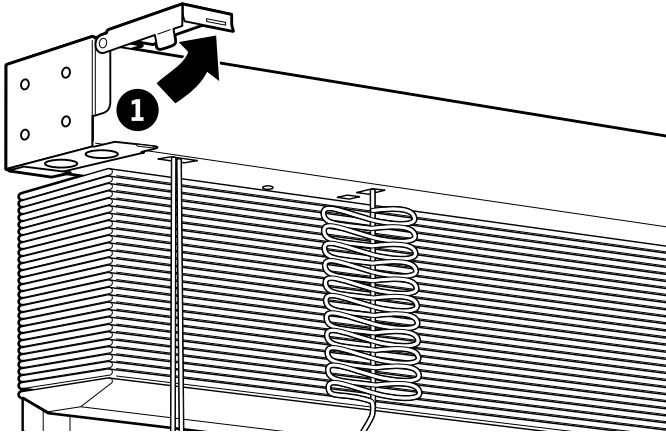

**CAUTION:** Hold blind firmly when removing. Failure to do so may result in the blind falling and possible injury.

### CLEANING PROCEDURES

Keep your LEVOLOR Wood and Faux Wood blinds looking their best by periodically wiping them with a soft cloth, a duster, or the brush attachment from a vacuum cleaner.

**NOTICE:** Avoid contact with window cleaning products. Improper cleaning may damage the blind and void warranty.



#### DUSTING

Use a feather duster for regular cleaning.



#### FORCED AIR

Blow away dirt and debris using clean compressed air.



#### VACUUMING

Use a low suction vacuum with a brush-type cleaner attachment; stroke lightly over the blind to clean.



#### SPOT-CLEANING/STAIN REMOVAL AT HOME

Faux Wood blinds only. You may use a soft, lightly dampened cloth to clean your Faux Wood blinds.

## CHILD SAFETY



**WARNING:** Inner cords can pull out to form a loop, which can STRANGLE a young child.

- Inner cord stop devices can reduce this risk if positioned correctly on the pull cords.
- If inner cord stop devices are more than 6 inches (153 mm) below the headrail when the blind is fully lowered, move them closer by following the inner cord stop device adjustment instructions.

### To position safety cord-stops:

1. Install blinds as directed by manufacturer, making sure headrail is securely fastened. Lower blind to maximum desired length and lock into place.

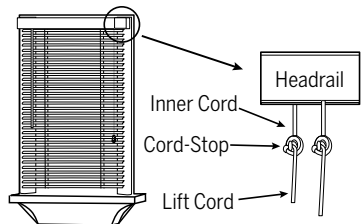

2. Measure the distance from headrail to cord-stops. If cord-stops are 1 - 2" below the headrail, no further adjustment is needed. Your blinds are ready to use.

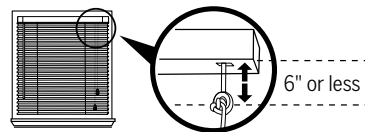

3. If cord-stops ARE NOT 1 - 2" below headrail, loosen (but do not untie) the knot surrounding the cord-stop.

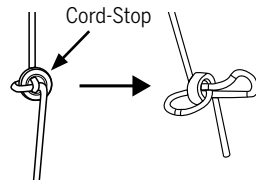

4. Push the cord-stop and the loosened knot toward the headrail until the cord-stop is 1 - 2" below the headrail.

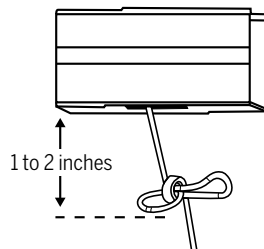

5. Hold cord-stop in place and firmly pull cord to re-tighten knot.

6. Repeat steps 3 through 5 for each cord-stop.

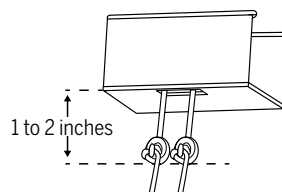

### **WARRANTY**

For complete warranty information visit [LEVOLOR.com](http://LEVOLOR.com) or call Customer Service at 1-800-LEVOLOR or 1-800-538-6567.

### **CONTACTING US**

To contact LEVOLOR Customer Service regarding any questions or concerns you may have about your new blinds, you may reach us at 1-800-LEVOLOR (8:30 am – 6:30 pm EST)

**[www.LEVOLOR.com](http://www.LEVOLOR.com)**

### **ADDITIONAL PARTS AND SERVICES**

Additional or replacement parts can be ordered, or blinds can be repaired or restrung through our repair center. Please contact LEVOLOR Customer Service through [www.LEVOLOR.com](http://www.LEVOLOR.com) for a return authorization number.

